

BAR516

Cadrage profilé en aluminium 5/16" x 11/16"
5/16" x 3/4" Aluminum Roll-Formed Screen Frame

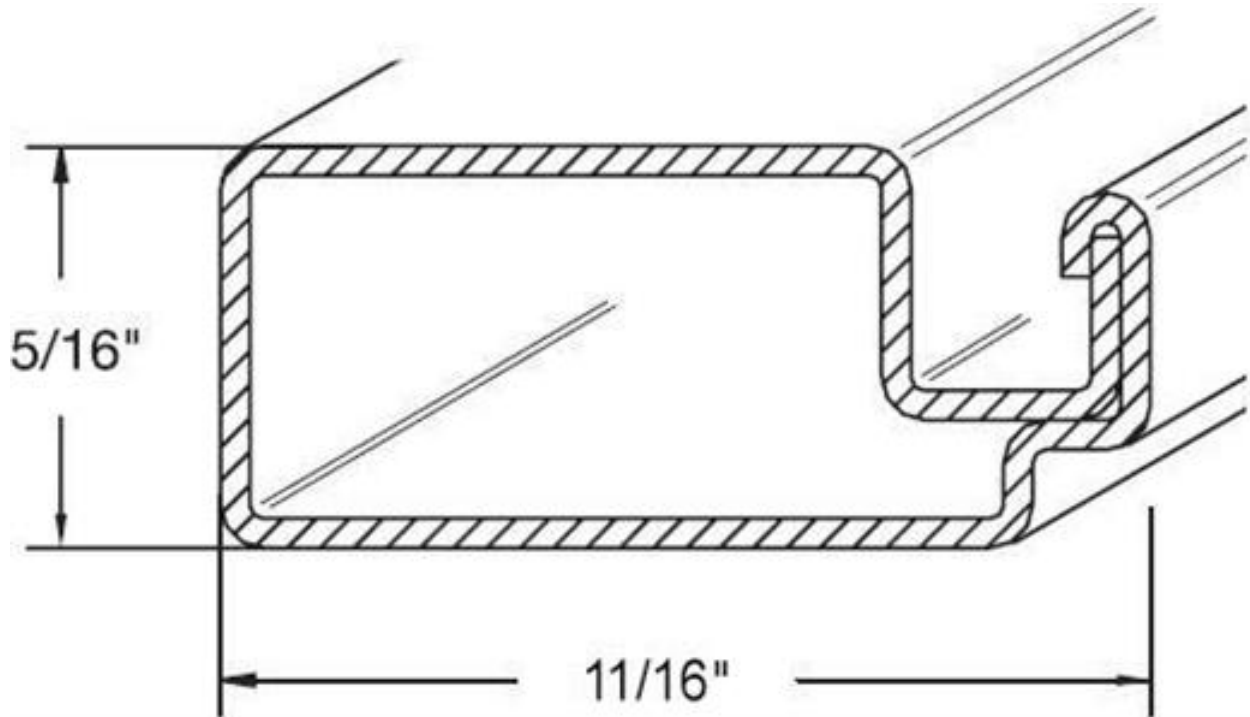

Type de cordon	Type de toile	
	Fibre de verre	Aluminium
Cordon en Polyéthylène	.135	.125
Polymousse	.170	

Emballage standard: 140 mcx x 12.5 pi.

Poids/bte: 108 lbs

Dimensions de la boîte: 8" x 146" x 5"

Spline type	Mesh type	
	Fiberglass	Aluminium
Poly Spline	.135	.125
Polyfoam	.170	

Standard packaging: 140 pcs x 12 pi.

Carton weight: 108 lbs

Carton dimensions: 8" x 146" x 5"