

BAR38LI

Cadrage profilé en aluminium 3/8" x 11/16" avec rebord 1/4" pour application intérieure
3/8" x 3/4" Aluminum Roll-Formed Screen Frame with 1/4" Lip for Inside Application

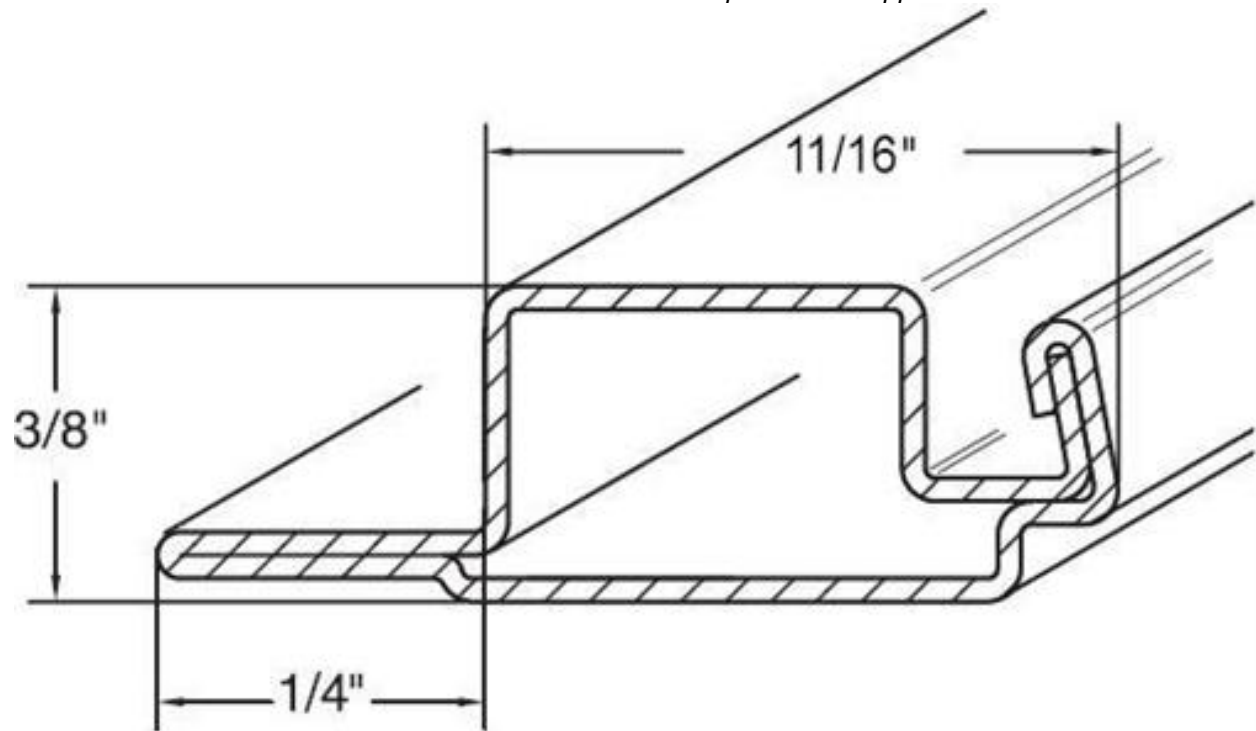

Type de cordon	Type de toile	
	Fibre de verre	Aluminium
Cordon en Polyéthylène	.156	.135
Polymousse	.170	

Emballage standard: 110 mcx x 12 pi.

Poids/bte: 104 lbs

Dimensions de la boîte: 8" x 146" x 5"

Spline type	Mesh type	
	Fiberglass	Aluminium
Poly Spline	.156	.135
Polyfoam	.170	

Standard packaging: 100 mcx x 12 pi.

Carton weight: 104 lbs

Carton dimensions: 8" x 146" x 5"